



Art 177XS1: Paper waste basket with swing lid
Art 177XS1: Cestino gettacarta con coperchio basculante
Technical product sheet
Scheda tecnica prodotto

Art:177XS1



Capacity: 8 liters.
Frame: AISI 304 (18/10) ground.
Equipped with non-slip rubber feet.

Quantity per pack: 1

Capacità: 8 litri.
Struttura: acciaio inossidabile AISI 304 (18/10)
satinato.
Piedini di appoggio in gomma .

Pezzi per cartone: 1

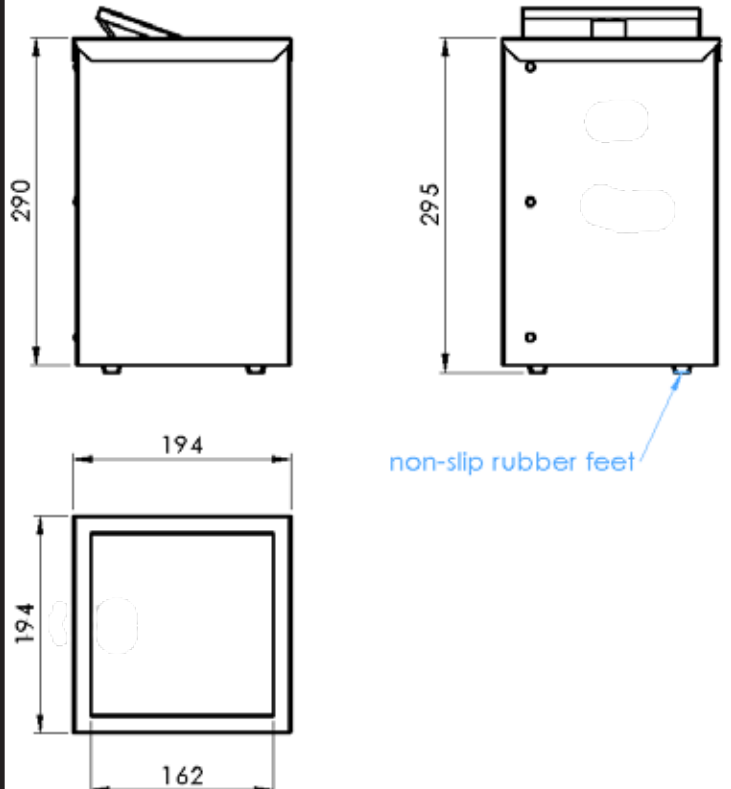

Article	net weight	gross weight	pack. dimensions	EAN
A177XS1	KG 2,0	KG 2,3	21x21x31,5 cm	8058269250362